

Final Report

Team 12

Development of Hammer Blow Test to Simulate Pyrotechnic Shock



Members:

Luis Lopez (lel12b@my.fsu.edu)
Max Mecabe (mwm12@my.fsu.edu)
Tiffany Shaw (tas12e@my.fsu.edu)
Justin Vigo (jlv11b@my.fsu.edu)
Sarah Wyper (saw10f@my.fsu.edu)

Faculty Advisor:

Dr. Rajan Kumar (rkumar@fsu.edu)

Sponsor: Harris Corporation

Robert Wells (rwells01@harris.com)

Instructors:

Dr. Nikhil Gupta (ng10@my.fsu.edu)
Dr. Chiang Shih (shih@eng.fsu.edu)

4/8/16



Table of Contents

Acknowledgements	i
Abstract	ii
1.1 Introduction	1
1.2 Problem Statement	2
2.0 Project Scope	2
3.0 Project Objectives	2
4.0 Background	3
5.0 Concept Generation	4
5.1 Anchoring	4
5.2 Decoupling	6
5.3 Hammer Pivot	8
5.4 Sacrificial Plate/Mounting Plate	9
5.5 Design of Experiments	11
6.1 Final Design Resulting Data	12
6.2 Abaqus Models	21
7.0 Design for Manufacturability	22
8.0 Design for Reliability	25
9.0 Design for Economics	27
10.0 Operations Manual	29
10.1 Functional Analysis	29
10.2 Project Specifications	30
10.3 Product Assembly	30
10.4 Operations Instructions	32
10.5 Troubleshooting	37
10.6 Regular Maintenance	37
10.7 Spare Parts	37
11.0 Project Management	38
12.0 Conclusion	42

ACKNOWLEDGEMENTS

The members of Team 12 would like to express our great appreciation to our sponsor, Harris Corporation and the FSU-FAMU College of Engineering faculty; this project would not be possible without their help. We would like to thank Mr. Robert Wells and his colleagues at Harris for providing this project and for their contributions of both time and resources to help get us pointed in the right direction. We would also like to acknowledge our faculty advisor, Dr. Kumar for his guidance and allocation of important resources. Lastly, our senior design instructors Dr. Gupta, and Dr. Shih for helping us with the planning and execution of this design task.

ABSTRACT

In order to ensure safety and a properly functioning system, thorough tests need to be done on every operational part. This is especially true for systems that encounter and make use of pyrotechnic shock. Many advanced systems use controlled explosive devices to accomplish tasks. Examples include rocket separation, pilot ejection, and air bag deployment. During these events it is critical that the components involved with the explosion and those surrounding it, especially the electronics, maintain functionality. This project aims to improve upon the pyrotechnic shock testing system that currently exists at Harris Corporation. A hammer blow impact test device has been built by a previous design team, but the resulting data lacked consistency and repeatability which provided little insight. The goal of this year's team is to capitalize off of the work of the previous design team while also implementing the necessary design changes in order to produce a repeatable pyroshock test that can be used to gain further understanding of the variables involved with pyroshock testing. To accomplish this several design changes were proposed and analyzed. The appropriate design changes that should be implemented consist of: a bearing hinge at the hammer pivot point, decoupling the frame and plate using a suspension system, stabilizing the entire device via anchoring, and making use of an electromagnetic release mechanism. So far the device has been anchored and the pivot has been replaced. The next steps in the project include trying to obtain repeatable results while also looking into electromagnetic release mechanisms and decoupling of the strike plate. Once repeatable results are obtainable, tests will be run in order to determine how variables affect SRS curve results.

1.1 INTRODUCTION

Currently at Harris Corporation there exists a device to test high frequency impacts as a result of explosions. These high frequency impacts are meant to simulate what is referred to as pyrotechnic shock or pyroshock. It is important to analyze how these shocks affect electronic components because they typically occur within a close range of hardware that is crucial to the integrity of the system. The current device at Harris Corporation is capable of replicating pyroshock, but due to the nature of pyroshock, it is generally difficult to create repeatable test data. As a result, a great deal of time and resources have been invested in understanding the nature of shock response. The goal of this project is to create a device that simulates pyroshock in a repeatable manner so that researchers can gather meaningful data in order to further their understanding of the effects of pyroshock by changing several different parameters. These variables include strike force, strike location, and sensor location. This is the long term, final goal for the project.

It is important to note that this project is a continuation from Team 15's work last year. Team 15 set out to achieve the same goals, but were unable to accomplish the task in one school year. It is also important to note that Team 15 encountered many of the same issues that affected Harris' current device and which contributed to the ideation of the project. Within the provided school year, the team was able to produce a working test device that simulates pyroshock, but the device struggles with repeatability, and therefore cannot provide much insight for Harris in its current state. It is the goal this year to use the results from Team 15's efforts to create a device that produces accurate repeatable experimental data. This report will provide an in-depth analysis of the project definition, along with the design and analysis that will be used to accomplish the task at hand and the methodology for implementing these ideas.

1.2 PROBLEM STATEMENT

Harris Corp. has expressed a need for an apparatus enabling an accurate simulation of pyrotechnic shock via a hammer mechanism. The first prototype constructed the previous year, while fulfilling its purpose of gathering information on high load and high frequency shock, yielded noisy data as a result of too many parameters and high tolerances within the structure of the mechanism [1]. A device that is more stable and that would yield more repeatable results is desired in order to test the variables surrounding pyrotechnic shock. There is a need to gather knowledge and data involved with pyrotechnic shock and the variables that affect it.

2 PROJECT SCOPE

Based on the reports from Senior Design Team 15 last year and discussion of the goals for this year, the following goal statement was developed: Optimize the test device's stability and repeatability and in turn develop a better understanding of relations between various test fixture parameters and resulting SRS curves.

3 PROJECT OBJECTIVES

The following is a list of objectives for this project [2]:

- Research existing methods for simulating and testing shock responses
- Improve repeatability of last year's test device
- Improve hammer mechanism stiffness and release from last year's device
- Evaluate designs in order to decouple the attachment of plate to frame
- Optimize processing for modeling SRS curves
- Improve FEM analysis process using results from improved test device

Team 12 Development of Hammer Blow Test to Simulate Pyrotechnic Shock 2

- Reduce set of parameters used for tests from last year
- Perform impact tests with improved device and improved modeling

An additional goal, if time permits, is to work on adding damping effects, more mass, and stiffeners to the fixture plate and analyze these results against the previous ones [2]. Table 1 displays what was specifically provided by our sponsors at Harris

Requ. #	Category	Description
1	Mechanical	Refine impact test device and fixture plate developed on year 1 project to improve repeatability.
2	Mechanical	Evaluate SRS generation from year 1 project and develop improvements to speed up processing
3	Mechanical	Fabricate design improvements and validate repeatability. Use results to improve FEM analysis process.
4	Mechanical	Perform impact test on fixture under a reduced set of test parameters. Test parameters to be identified by Harris by SDR.
5	Cost	Bill of Materials shall be generated early enough to budget costs for test fixture improvements and any needed instrumentation purchases
6	Mech (stretch goal)	Evaluate ability to tune fixture plate by adding damping, mass, stiffeners. Correlate results to FEM analysis

Table 1- Requirements Provided by Harris for Second Year Project

4 BACKGROUND

Pyrotechnic shock can result in violent reverberation of a material or structure as a result of the high force explosion or impact. Beyond the conventional use of explosives to cause intended damage, controlled explosions can be used to accomplish tasks. It is not uncommon for explosives to be used in various applications in the aerospace industry. Examples of this include but are not limited to rocket separation, pilot ejection, airbag inflation, and payload deployment [#]. It is of significant importance that the components that are surrounding or involved with the explosions survive the occurrence and are able to complete their tasks resulting in a successful outcome rather than a failure after detonation.

Numerous methods exist for replicating and analyzing pyroshock, but in general most computational models encounter difficulty with the resources required. These difficulties often stem from a combination of the large forces involved and the very large frequency at which they occur. Finite element analysis

(FEM) encounters such an issue modeling the shock due to its high frequency characteristics. Most commonly used to record the results of such a test is what is referred to as the Shock Response Spectrum or SRS. The SRS facilitates the analysis of shock on the component in the frequency domain, rather than transient shock in the time domain. The SRS shows peak acceleration of a predetermined series of natural frequencies that would be imparted by a certain shock [3].

The rapid decay, transient nature, and extreme frequencies are difficult to simulate using a shaker to induce vibrations. Mechanical shock inputs such as pneumatic and hammer blow tests can yield optimal results, yet are time consuming in their tuning [4]. Additionally, the shock imparted often cannot be subjected directly to the component in testing, but through a mounting which could have substantially different mechanical properties thereby hindering the accuracy of the results [3]. High acceleration shock loadings are more accurately created by explosives; however, this is rarely done in practice due to the obvious dangers [4].

Electronic components have also been shock tested through the use of drop tests, but it has been found that these tests tend to overestimate the shock accelerations and their resulting damage. Harris corporation has also found this to be the case through their research. Also some sources have noted error do to the use of an accelerometer to record measurements of pyroshock, but these issues can be potentially solved through the use of mechanically simulated pyroshock as opposed to the use of actual pyrotechnics.

5 CONCEPT GENERATION

Since the test prototype had already been built by last year's senior design team the main focus for this year was to alter and optimize the design for repeatability. There were five main components to consider in order to accomplish this including decoupling the test plate from frame, anchoring the rig, improving handle, improving release mechanism, and minimizing other inhibiting variables.

5.1 ANCHORING

One of the biggest issues with last year's design of the test rig was its weight. Although the slender frame was light enough to be transported easily it was also consequently easily moved during testing (due to the high impact of force applied.) The test rig would move up to three inches alongside the floor after impact. This caused considerable variability within the data and created far less than ideal conditions for testing vibrations. Anchoring the rig became the first obstacle for our team to overcome. The most obvious solution to this issue was to anchor it to the floor; the most secure form of anchoring possible, although putting sand bags on the frame was suggested by sponsor Harris Co. FAMU & FSU College of Engineering prohibited drilling directly into the ground surface of any indoor structures belonging to the college other solutions were sought after. Eventually the Newport Instrumentation Table was discovered in the mechatronics II lab which weighed 528lbs and was capable of securing the frame and preventing movement during testing. Below is a stock photo of the model table which was used.



Fig 1-Newport Instrumentation Table

The frame was secured to the table with eight two-hole aluminum straps with foam padding to equalize force distribution. Below is a side by side comparison of the before and after anchoring conditions. The left figure shows how much the frame moved after running one test. The vertical screw is used as a reference point to show where the frame was before the test was ran. It can clearly be seen in the figure on the right that the frame did not move at all from the reference point.



Fig 2-Before Anchoring

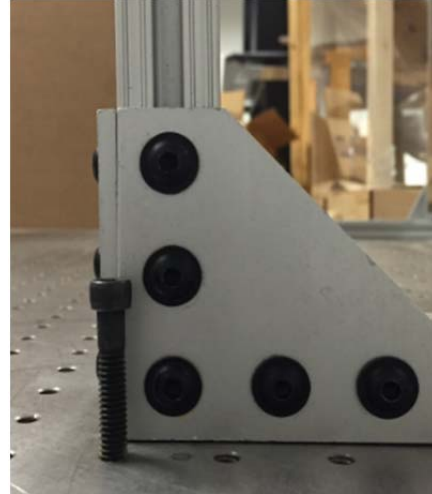

Fig 3-After Anchoring

5.2 DECOUPLING

In order to obtain the cleanest data it is important to isolate the system from outside variables that could interfere with the vibratory data. One step in achieving this is decoupling the test article from the frame. There were two initial designs proposed including a tethered plate design



and spring damper design. The tethered design can be viewed below in Figure _.

Fig 4-Tethered Plate Design

In the above design the test plate is suspended in all four corners by bungee cord. Although this design would isolate the plate from the frame there are other considerations such as possible large oscillatory movement by the test plate in the y-plane. This could damage the wiring and/or accelerometer as well as negatively affect repeatability. The next design concept proposed can be



seen in the next figure below.

Fig 5-Spring Damped Design

In this design the test plate would be mounted on four springs or one in each corner. A close up view of such spring can be seen in the Fig_. Although these design concepts are worth exploring when time and money is not of any consequence, it was in our best interest to explore more time efficient and less evasive ways to decouple the plate from the frame. We decided that since rubber has damping qualities, that placing rubber pads between the test plate and the L-brackets was worth trying out. This design can be seen below. This figure shows a top down view on one single corner of the test plate.

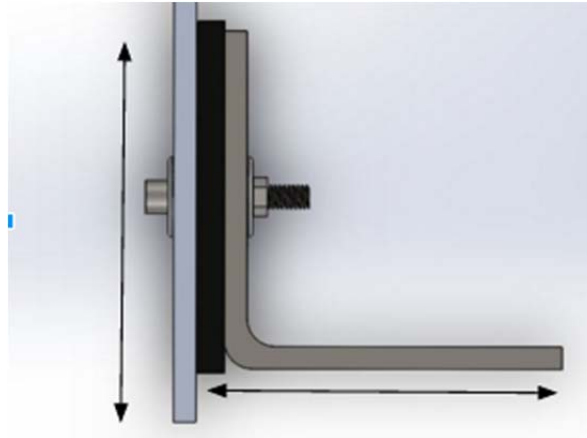
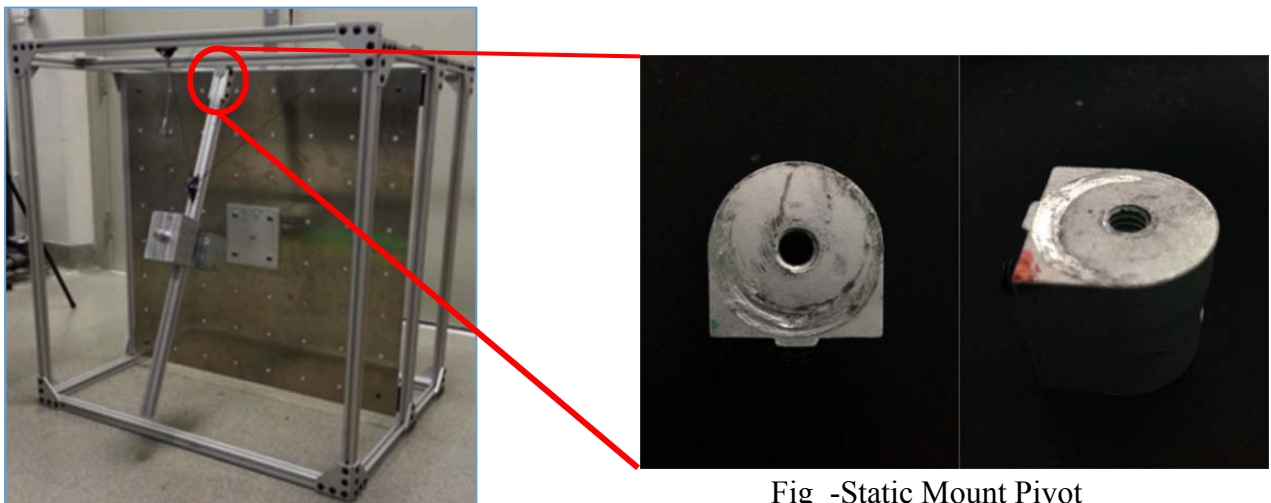

Fig 6-Rubber Decoupled Design

The design aspects of this project occurred alongside troubleshooting and testing, so it was in our best interest to choose this rubber design model.

5.3 HAMMER PIVOT

Another aspect of the design that was in need of improvement in order to perfect the testing conditions and optimizing the system for repeatable results was the hammer arm pivot.



Fig_-Static Mount Pivot

Fig_-Hammer Pivot Location

The above figures shows the location of the hammer pivot and the substantial wear on the part. This static mount pivot was not designed for a swinging arm joint and created unwanted side to side motion, interfering with the data. We upgraded this pivot for a dynamic pivot with lubricated bronze bushings.

5.4 SACRIFICIAL PLATE/MOUNTING PLATE

In the pursuit of perfecting testing conditions and elimination of outside or unnecessary variables from affecting our data we reconsidered the sacrificial plates role in our experiment. The sacrificial plate was originally designed to protect the test plate from the hammer's high impact however it invariably affected the vibratory nature of the test plate which is very thing we were interested in. The sacrificial plate is located in the figure below (positioned at the strike location of the hammer.)



Fig 7-Sacrificial Plate Location

At first we believed this to be a necessary part of the design since the test plate is expensive to replace and the relatively small sacrificial plate was easy to on the contrary extremely easy to replace. We found that in our raw data (time domain) we were recording a second unexplained spike, which we attributed to the sacrificial plate separating and hitting the test plate within milliseconds of the first hit. In order to correct for this we tested out a series of oils and heavy duty bearing grease in order to lubricate the plates creating a suction or vacuum to dampen the second hit. Although this improved the results it did not correct the second spike in data. We concluded that the only way to know if the second spike was directly caused by the sacrificial plate is to run the test without it and see if it disappeared. When we ran such a test we found that the second spike was again unaffected. Although we did not understand the origin of the second spike we did realize that the risk of damaging the test plate was significant enough to justify the interference of adding a sacrificial plate which lead to us abandoning that aspect of the design altogether.

This lead to the reconsideration of the accelerometer mounting plate which can be seen in the

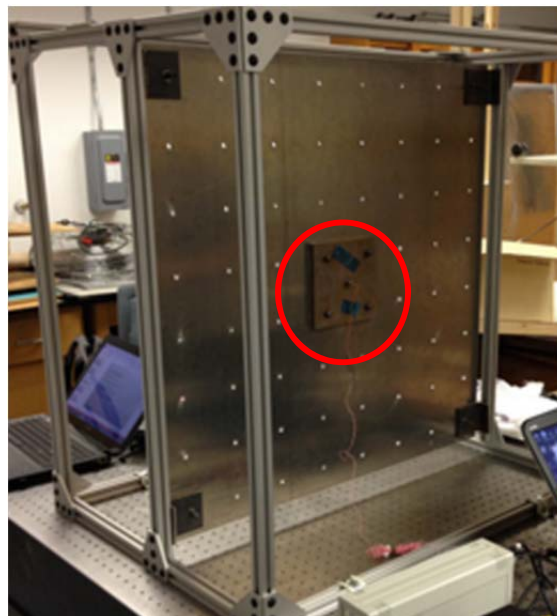

figure below.

Fig 8-Accelerometer Mounting Plate

The above figure shows the rear side of the frame and the accelerometer mounting plate. This plate was made of steel in contrast to the rest of the aluminum design and consequentially interfered with the very sensitive vibratory data. It wasn't till the sacrificial plate was removed that the team realized that this plate must also be removed. Threaded holes were tapped into the test plate in order to mount to the accelerometer without the use of the steel mounting plate.

5.5 DESIGN OF EXPERIEMENTS

The first experiment aimed at accurately outputting SRS curves from nine different accelerometer locations. A 5kg mass was used for the hammer for each of the nine impacts. For each test, the swinging arm was manually raised by a team member and held against the highest position allowed by the testing apparatus. A second team member would trigger the data acquisition system (via LabView) then immediately notify the first team member to release the hammer mass. Note that before and after each test in this 9-point experiment, each of the supporting bolts for the test plate were tightened by hand until the bolts didn't turn anymore. The data acquisition system was left running for approximately one second in order to capture the shock response data. For each test, the recorded voltage data from the accelerometer was outputted to an Excel file and converted (with the conversion factor of 0.522mV/g) to G-force with respect to time. This data was then offset in order to be centered about zero. Using the MATLAB code provided by Harris, the time-dependent shock response data was transformed into each of the test's respective shock response spectrum curves (SRS curves).

The second experiment was geared toward investigating the effect of hammer strike locations at all nine points of interest on the test plate. The accelerometer was kept in the center of the nine-

by-nine square during this experiment. Testing was conducted in a similar fashion to the first experiment, but before and after every impact test on the same vertical position on the grid of strike points, the position of the swing arm was moved along the bar connecting it to the rig. After taking three tests at any one row of strike points, the position of the hammer head along the swing arm was adjusted accordingly so to strike along the appropriate vertical position on the nine-by-nine grid. This system was used to efficiently strike the test plate at the nine locations of interest.

It is important to note that neither the test article nor any sacrificial plates were used during the 9-point experiment.

6 FINAL DESIGN'S RESULTING DATA

The purpose of the design implications discussed above are all in pursuit of perfecting the system and optimizing the conditions in order to produce repeatable results. Only after repeatability is obtained can the process move on to better understanding the nature of pyrotechnic shock and their resulting SRS curves. Below is a set of theoretical curves that show us the range of

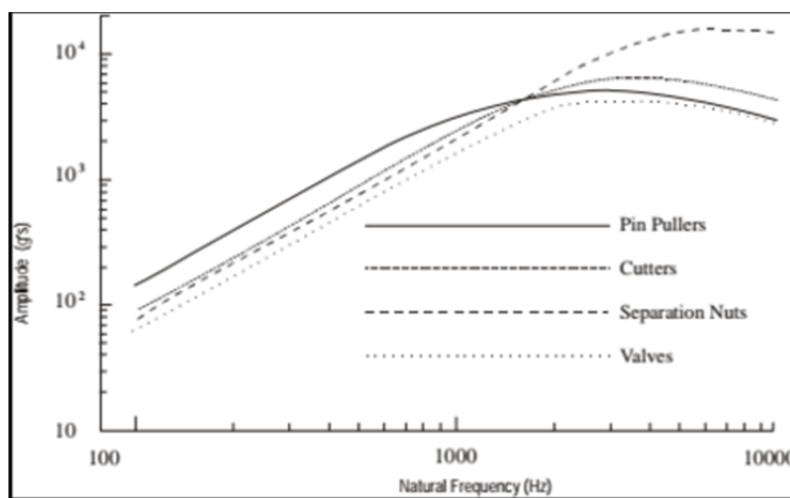

amplitudes we should find our data to be in and the trend that they should also replicate.

Fig 9-Theoretical SRS Curves

In order for our results to be considered repeatable the data must fall within plus or minus 3dB over a minimum of 90% of the SRS curves and the remaining 10% fall within plus or minus 6dB. By running multiple trials of the specific set up and taking the standard deviation of the

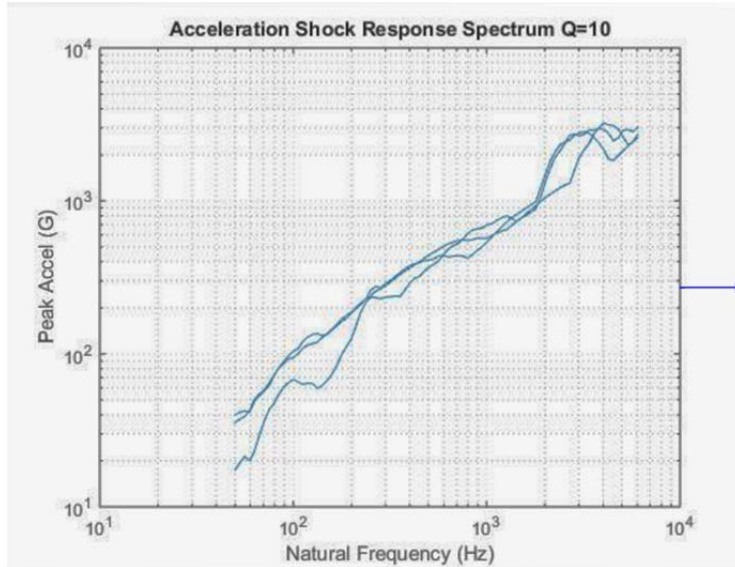

results the repeatability of the test can be determined. The initial results of the test after the anchoring the rig and upgrading to a dynamic hammer arm pivot the repeatability results increased drastically and can be seen below.

Fig 10-Beginning Trials With New Design Features

The next design implications that were tested was the rubber damping model. Rubber pads were inserted at the L-bracket contact points and data was collected. The resulting SRS curves are

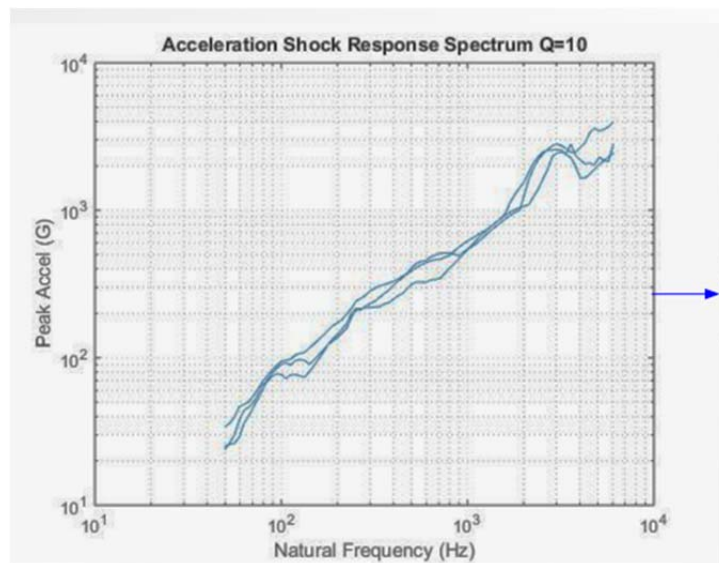

pictured below.

Fig_11-Rubber Damped Design

In comparison to the initial trials it is clear that the rubber dampers improved the repeatability and the overlay shows that the standard deviation between trials decreased. At this point rubber dampers washers were placed between the bolts and the test plate in order to further increase the

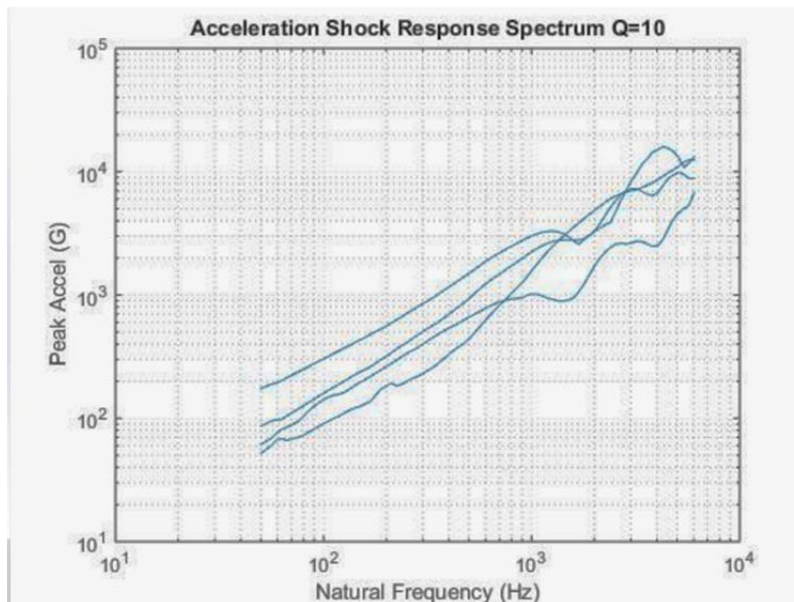

repeatability and the results are shown below.

Fig 12-Rubber Washer Design

As can be seen in the above figure the rubber washers caused our system to deviate from trial to

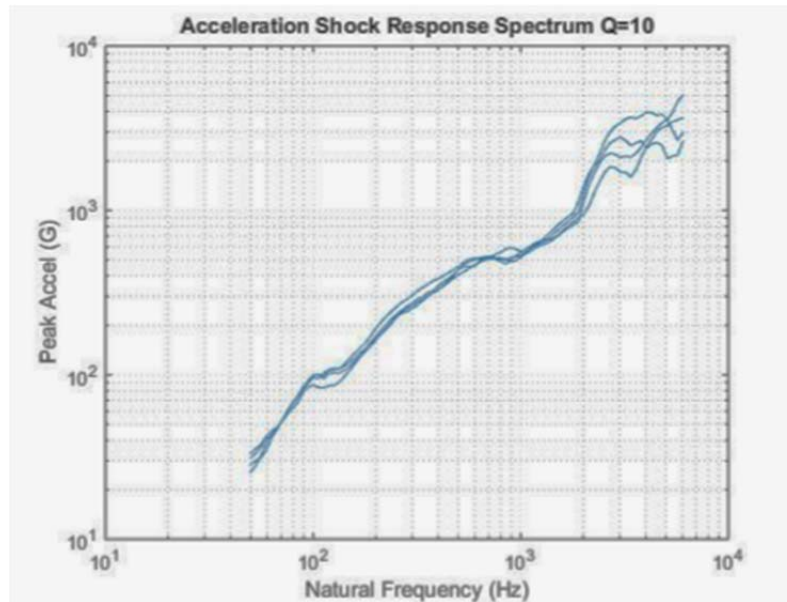

trial severely sacrificing the sought after repeatability that was aimed for. Although in theory the rubber washers should have further damped the system they were not strong enough to be tightened securely and withstand the forces associated with pyrotechnic shock simulation. The importance of secure bolts after these test runs were realized and trials were completed with each and every bolt in the design tightened to its maximum tolerance between each trial. The results for these trials are shown below.

Fig13-Maximum Tolerance Bolts

The data plot shown above shows that the repeatability of this test design is extremely repeatable as the different charts overlay within the allocated dB tolerance through the entire graph. There are still some interferences seen within system shown by the minor bumps in the curves and the spick at around 3×10^3 Hz. In order to try to minimize these interferences the sacrificial plate as well as the accelerometer plate were removed. The SRS curves for these trials are displayed below.

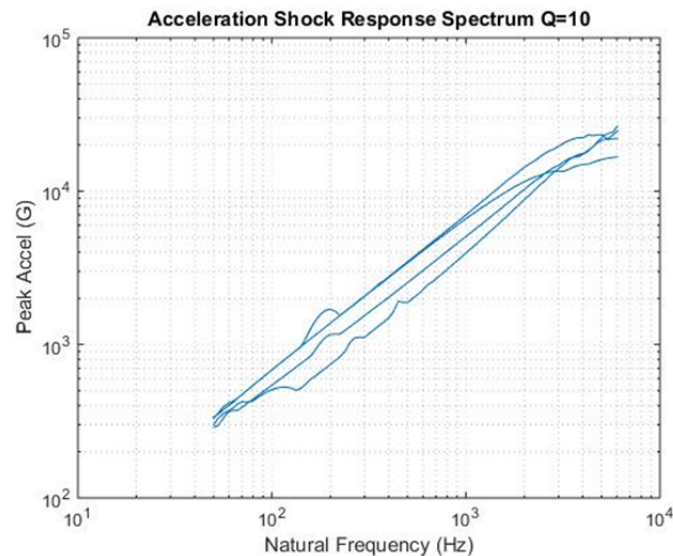

Fig 14- No Plates Set Up

The set of data shown here show much less interference since the curves are significantly more smooth however the deviations from trial to trial have increased lowering the ‘repeatability’ of the set up. This is of great concern and interest however there are many reasons why this occurred.

In addition to the smoothness of the curves the shape of the curves tend more toward a logarithmic shape which is the theoretical behavior of pyrotechnic shock curves.

Although repeatability can always be improved in regards to pyrotechnic shock simulation, another goal in addition to obtaining repeatable results for this project is to understand how changing variables in the test setup design can change the resulting SRS curves and further understanding the nature of pyrotechnic shocks. In order to pursue this understanding specific variables were where changed while keeping the rest of the setup the constant. The first variable that was considered was the sensor location. The accelerometer mounted on the rear side of the

test plate was moved to eight different locations on the back of the test plate (the ninth location was the center which was already tested every previous trial). The strike location of the hammer in these cases were kept constant at center center and five or more trials were conducted for each case. The results of these trials are seen below.

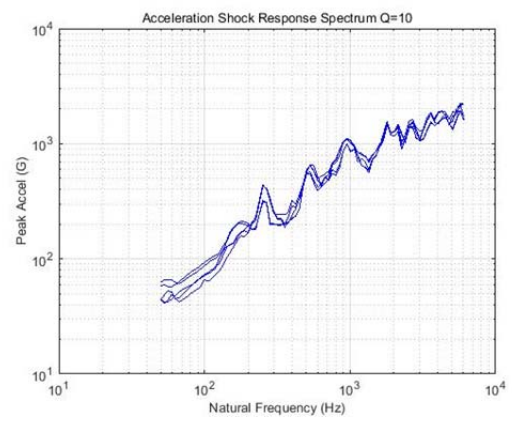
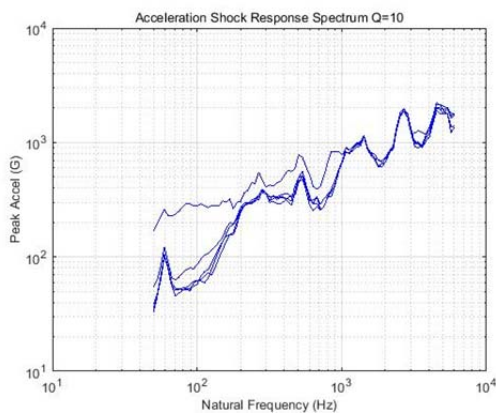
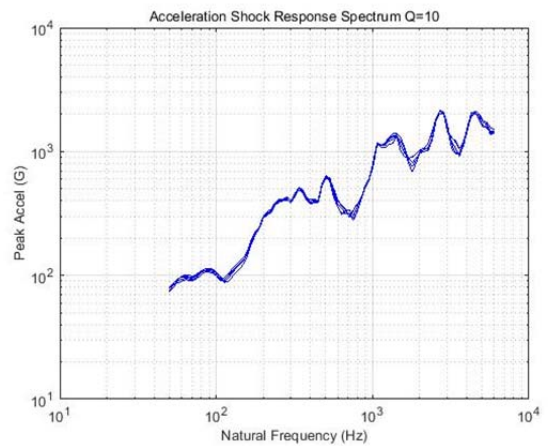
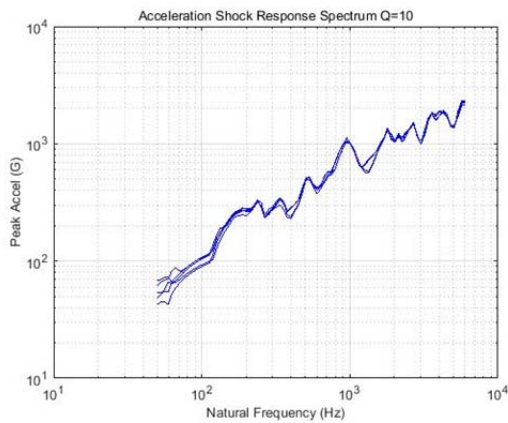
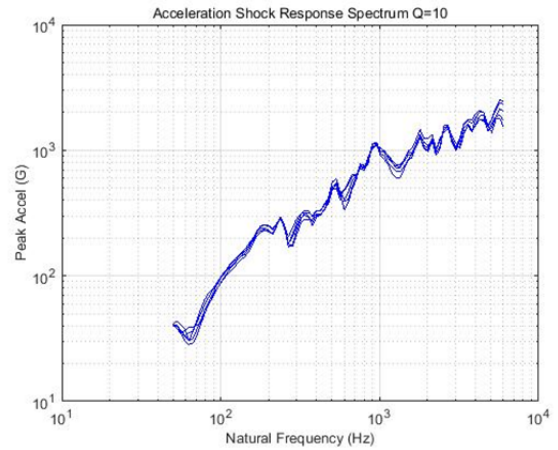
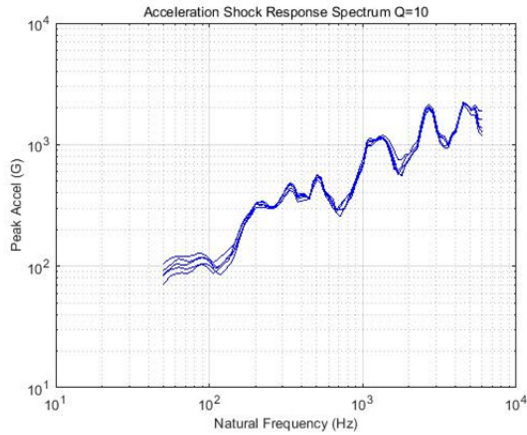

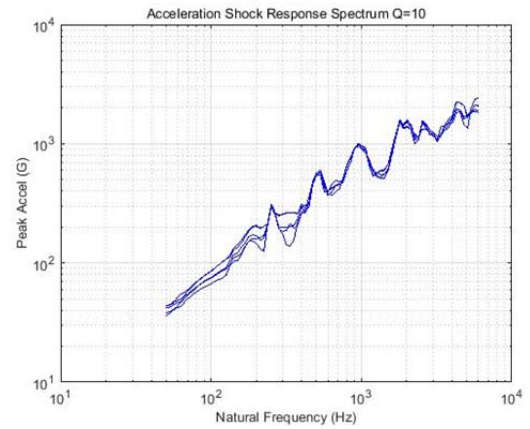
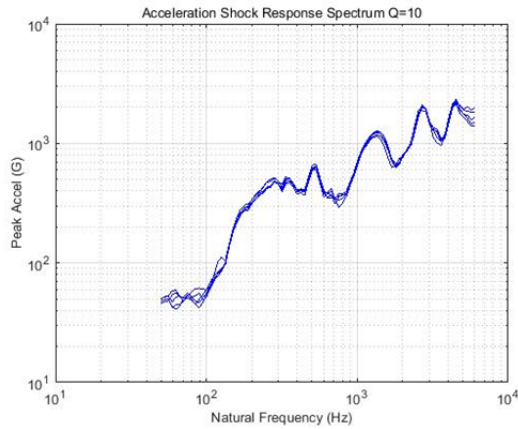
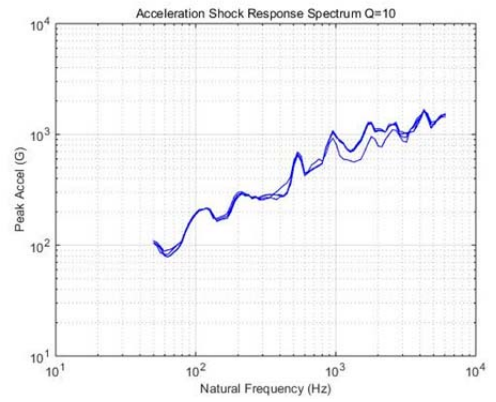
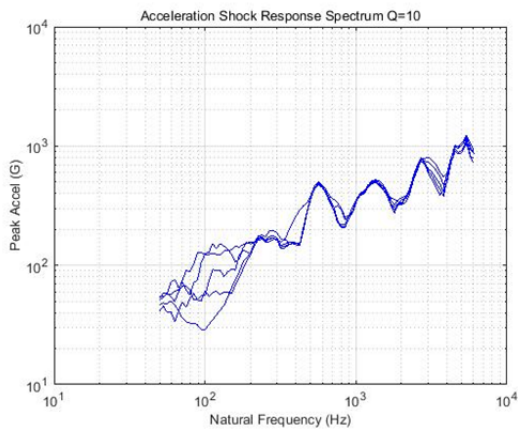
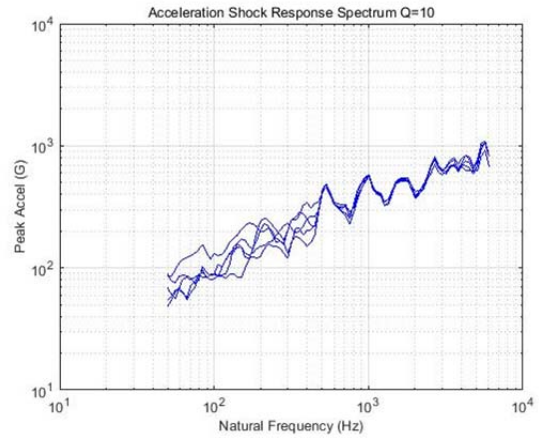
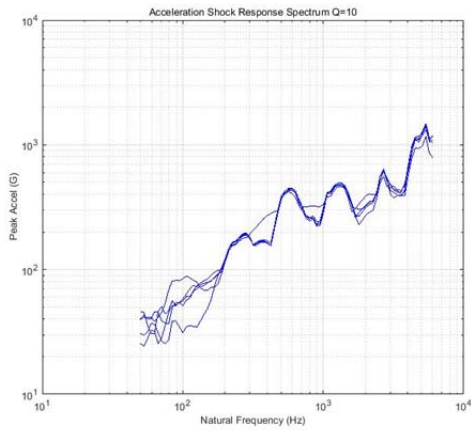

Fig 15- SRS curves for accelerometer readings (beginning from top-left, going right and down); no middle reading

The next variable which was tested was the strike location. The sensor during these trials was kept at center center and the hammer strike location was tested along each of the eight other locations (the ninth is center center which has already been tested). Again for each case there were five or more trials conducted, and the results are shown below.



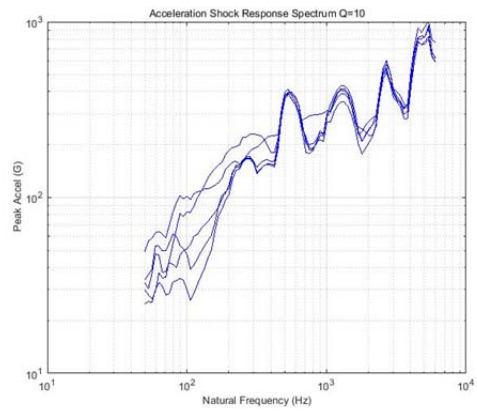
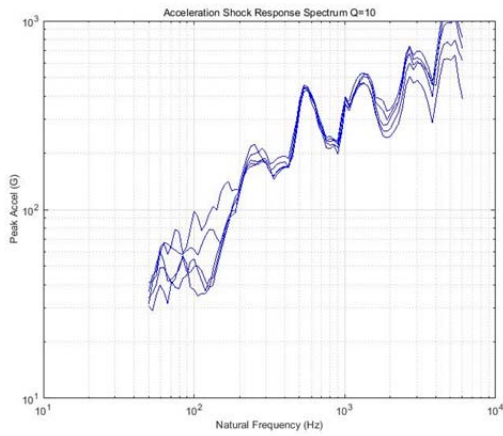
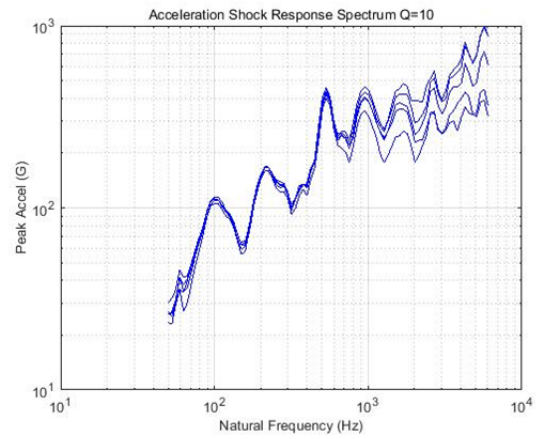
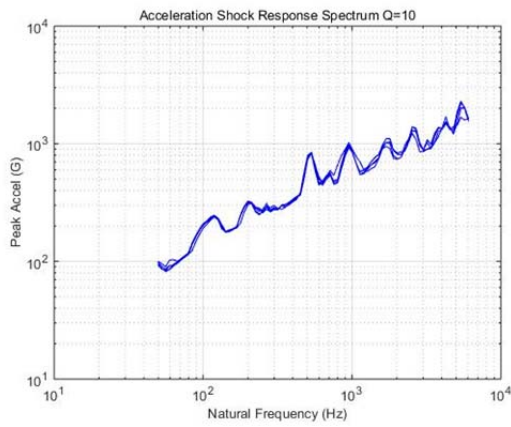

Fig 16- SRS curves for different strike locations (beginning from top-left, going right and down); no middle reading

6.2 ABAQUS MODELS

An important aspect of understanding pyrotechnic shock curve propagation is also understanding the force amplitude from impact and the high points or stress locations. Abaqus modeling software can provide a visual for such a system. The figure below shows the test plate stress locations for our final design with a top right strike location. It can be seen that the although the peak stress occurs at the strike location with another peak occurring at the center and the propagation of force or stress from this initial contact point is not symmetrical about any axis.

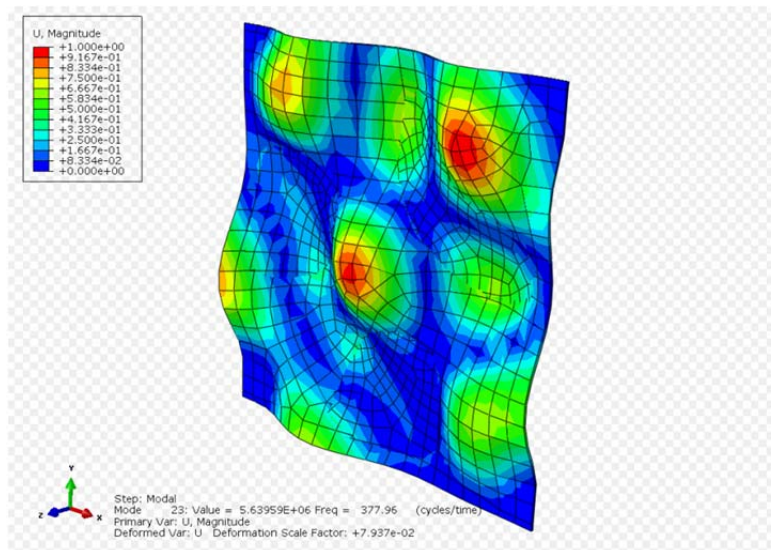

Fig 17-Abaqus Model Of Final Design

This figure below shows the back front views of the and center-center strike location. The force distribution is equal and symmetrical about the x and y-axis.

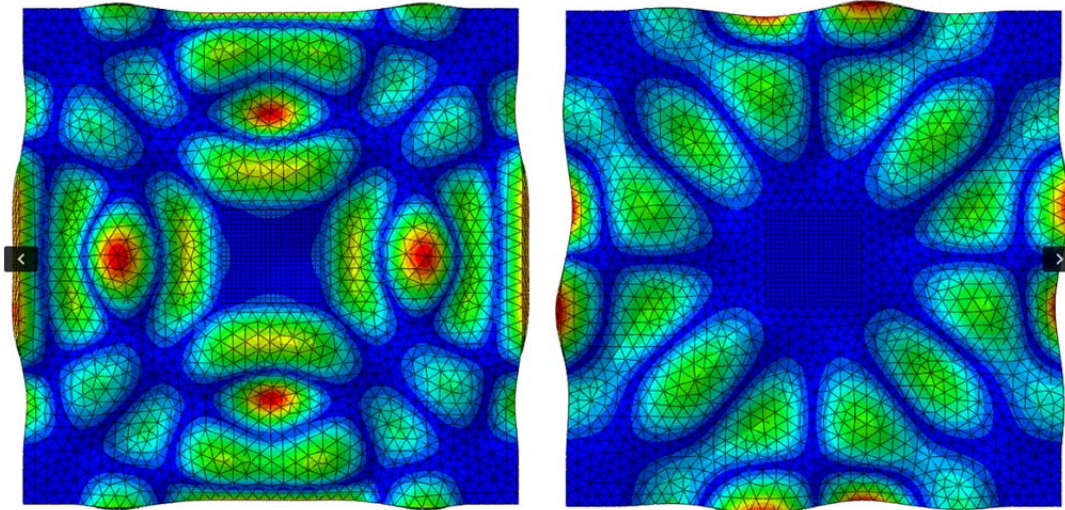

Fig 18-Stress Locations Front and Back Views

7 DESIGN FOR MANUFACTURABILITY

Because this was a continuation of a Senior Design project from last year, there was no new full assembly of the hammer blow test device. Minor adjustments were made to the device to improve the data collected by the accelerometer, but those changes include anchoring the frame to the instrumentation table using two hole aluminum straps, adding rubber pads between the strike plate and L bracket, removing the sacrificial plate on the front, and changing the hammer arm pivot to a dynamic pivot. All of these individual changes took an inconsequential amount of time relative to the time frame of the entire project.

A larger adjustment involved removing the mounting plate for the accelerometer on the back side of the strike plate and drilling holes into the strike plate in order to screw the accelerometer into the strike plate. It took only a couple hours to make this change. This new mounting of the accelerometer can be seen in Figure 1. Figure 2 shows the front side of the test device.

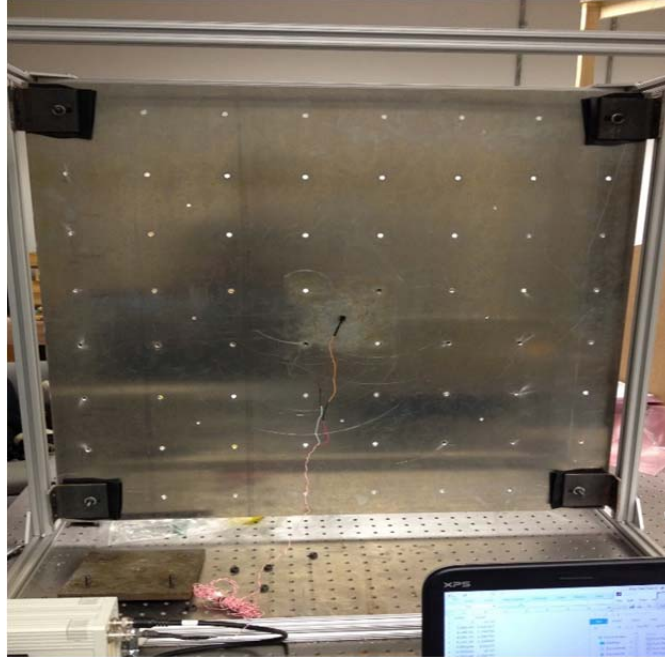

Fig. 19- Strike Plate with Accelerometer Mounted Directly



Fig. 20- Test Device

Figure 3 shows the CAD assembly of the device, with the minor changes mentioned earlier. Figure 4 displays a partially exploded view. This figure shows only the strike plate, hammer arm, and some of the frame exploded in order for simplicity and viewing

purposes. Also, the basic connections are all consistent, and thus no new connection types are not exploded.

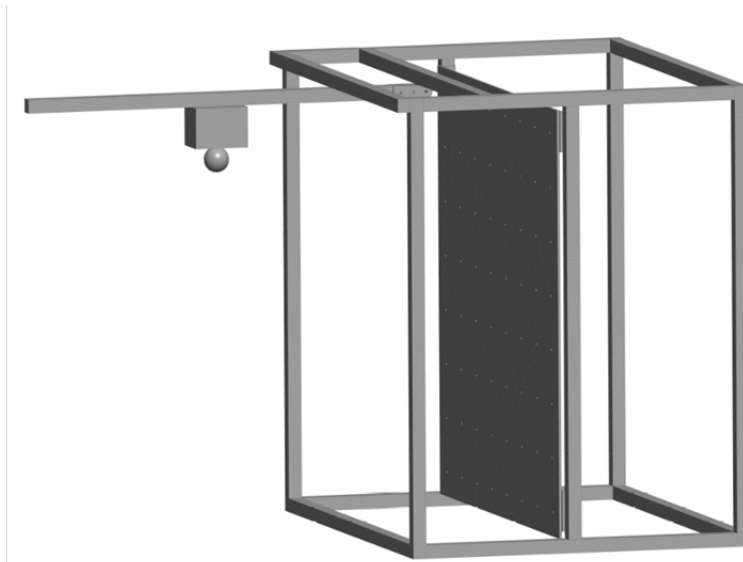

Fig. 21- CAD Assembly of Test Device

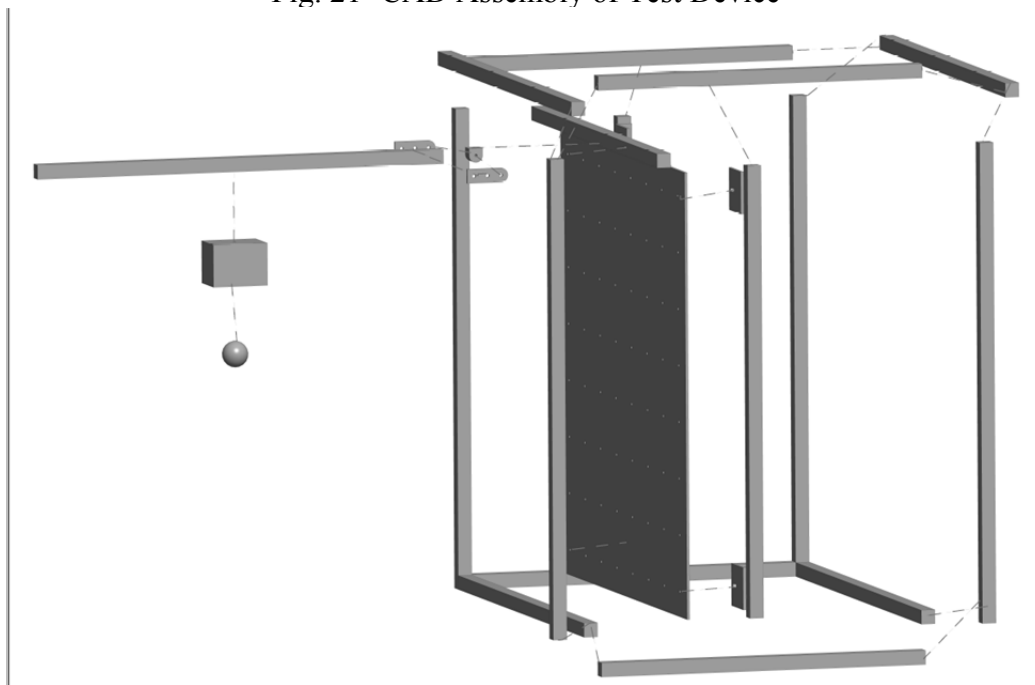

Fig. 22- Partially Exploded View of Test Device

Table 1 lists the components of this design. It can be seen that there are 4 major components. This design would probably benefit from greater complexity in order to eliminate some of the internal noise seen in the data, which cannot be corrected with any external

changes. For example, complete isolation of the strike plate from the frame would benefit the data and ensure all aspects of the SRS curves are caused by an intentional action of the hammer.

Table 1-Components of Hammer Test Device

1. Frame
2. Strike Plate
3. Hammer (Arm and Head)
4. Accelerometer and DAQ (including processing equipment)

8 DESIGN FOR RELIABILITY

Reliability is a prominent concern for this test apparatus. The main objective for this year relies heavily on collecting data and thus having a reliable test apparatus is extremely important. Last year's team did well when choosing the appropriate materials and attachments to successfully run a high number of trials for both years of this project.

However, the test itself has a mildly violent nature, and thus some deformation is seen and expected after running multiple trials. A big concern last year was the plastic deformation of the strike plate, so a plate named as the sacrificial plate was added to alleviate damage to to the strike plate. Plastic deformation was then expected to be seen on the sacrificial plate, so various plates were made to correspond with each hammer size. Their biggest concern last year turned out to be the hammer pivot, seen in their Failure Mode Effect Analysis (FMEA) in Figure 5. This was corrected this year by changing that static pivot to a dynamic pivot, which not only improved repeatability but addressed some of their failure concerns of the static pivot.

Table 4 - Failure Mode Effect Analysis of Physical Test Rig

Input	PFM	PFE	SEV	PC	OCC	Controls	DET	RPN	Action
Hammer	fracture	partial force generation, delay in future testing	6	inadequate material	1	pre/post test inspection, material selection	9	54	replacement-new material
Hammer arm	bending, fracture	partial force generation, delay in future testing	6	off center	1	pre/post test inspection, material selection	9	54	replacement-larger diameter
Arm pivot	bending, fracture	delay in testing, skewed results	6	cyclical fatigue	3	pre/post test inspection, material selection	6	108	replacement-new material
Quick release	premature/failure to release	no results, injury if premature	5	cyclical fatigue	3	pre/post test inspection, material selection	7	105	replacement-redesign
Mount size	sliding, rolling	partial force generation, damage to components, injury	7	incorrect size	2	pre/post test inspection, material selection	3	42	modification/replacement
Fixture plate	bending, fracture	skewed results, delay in testing, damage to accelerometer	7	off center	1	pre/post test inspection, material selection	4	28	replacement-new material/size

Fig. 23- FMEA from Team 15 Last Year

Table 2 shows the FMEA made this year since changes were made to the test apparatus that affect the components and failure modes. For example, the removal of the sacrificial plate means a larger concern for plastic deformation of the strike plate. However, Harris has assured the team that any damage from the hammer on the strike plate will not be of consequence considering the fact that strike location will be moved for the next set of trials. Removal of the accelerometer mounting plate means an increased damage possibility to the accelerometer, so it has been decided to not hit directly where the accelerometer is mounted, but slightly off axis. This damage possibility to the accelerometer has thus become the largest concern as seen by the Risk Priority Number (RPN) and Criticality rating (CRIT) in the FMEA table. The table shows that the identified failure modes for the other components have a much smaller severity, and are more easily corrected than if ordering a new accelerometer ever becomes necessary, especially at this point in the project.

Table 2- Team 12 FMEA

Component	Potential Failure Mode	Potential Effects of Failure	S	Potential Causes of Failure	O	Current Process Controls	D	RPN	CRIT	Recommended Actions
Hammer Arm	Bending	Skewed data, Decrease in repeatability status, Testing delay while fixing	6	Pivot damage, Mishandling, Material Failure	2	Inspection of part before running any tests.	1	12	12	If cannot re-correct arm, machine T-slotted Al bar to replace arm.
Hammer Head	Major deformation of Sphere Tip	Change in data, Decrease in repeatability status	6	Impacting strike plate with too much force for a large number of trials	3	Inspection of part before running any tests.	1	18	18	Change out sphere size when possible. Order new sphere if noticing problem.
Strike Plate	Deformation, Undesired Holes/Cracks	Bad data, Inability to make conclusions from test results	7	Too much concentrated force from one impact location	3	Inspection of part before running any tests. Use sacrificial plate when possible.	1	21	21	Do not run too many tests with same strike location for variable testing.
Accelerometer	Breakage	Inability to collect data, Inability to finish testing with time constraints	10	Mishandling, Direct impact by hammer	4	Inspection of part before running any tests.	2	80	40	Never hit accelerometer directly without any extra plates. Hit slightly off axis.
Frame	Loosening of screws at attachment points	Skewed data, Decrease in repeatability status	2	Violent nature of impact test	8	Inspection of part before running any tests.	1	16	16	Tighten of all screws with torque wrench after all full hammer swing test runs.

9 DESIGN FOR ECONOMICS

This project was originally given a \$5,000 budget for this year. Because the test device was already built, a significant amount of money was not spent, and thus this project can be deemed as economically sound. Figure 6 displays a pie chart of the the items purchased and what percentage of the budget they encompassed. It can be seen that approximately \$3,138.00 is expected to be remaining at the end of this project, when using an estimated value from last

year’s team for the team to travel down to Harris before the end of the semester. Table 3 lists each purchased item and its respective cost.

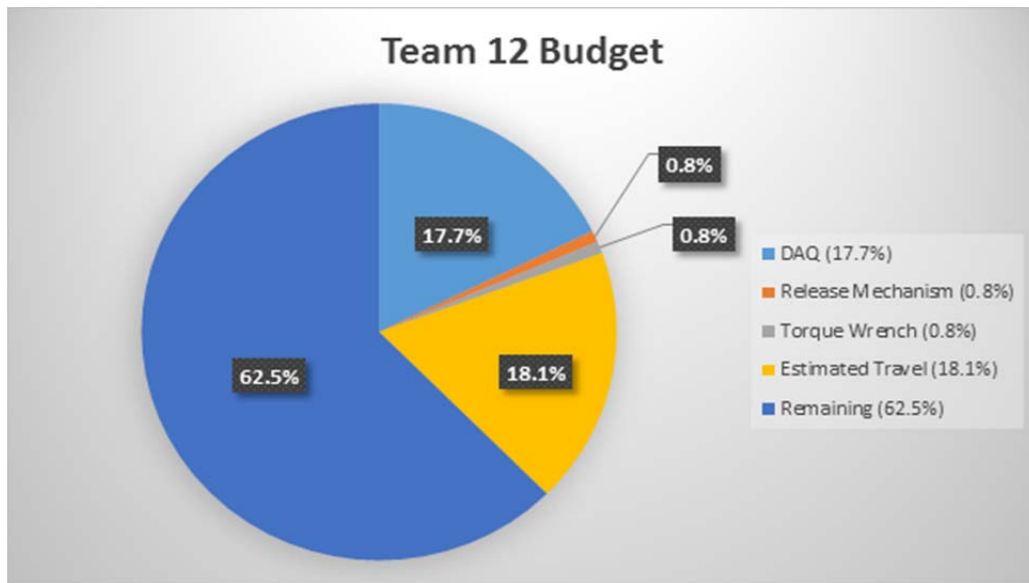

Fig. 23- Pie Chart of Purchased Items

Table 3- Individual Purchased Items

Part/Item	Price
National Instruments DAQ	\$880.00
GearWrench Torque Wrench	\$41.96
Electromagnet	\$13.39
Battery	\$20.00
Switch	\$6.88
Estimated Travel	~\$900.00
Total:	\$1,862.23

Similar test apparatuses to the hammer blow test device, designed by the team last year, have not been found on the market, thus making cost comparisons difficult. The total spent last year for just the device was approximately \$1,130.00. After working with this device for the second

year, various changes to the initial frame design could have been made in order to eliminate internal

noise that could not be corrected by external adjustments, and thus it can be inferred that more money could have been spent to design and build a device with fewer design flaws.

10 OPERATIONS MANUAL

10.1 FUNCTIONAL ANALYSIS

There are two major aspects to this project, and each is necessary to gather the desired data. The first, the Data Acquisition System (DAQ) is crucial for proper data collection and will be described more in depth later in this manual. The second is the physical hammer blow test. The device was originally built last year and minor changes for repeatability improvement have been made this year, but the basic operation stays the same. The procedure for running a test is listed below.

1. With the assumption that the apparatus is assembled and anchored down, tighten all connections, especially those associated with the strike plate using the torque wrench.
2. Attach the accelerometer to the back side of the strike plate (opposite of where the hammer swings), and screw into one of the nine threaded holes depending on desired test location. Ensure secure attachment. Accelerometer will protrude out to front side of plate.
3. On front side of apparatus, adjust hammer arm to match desired strike location by loosening pivot and sliding left or right. Tightened at desired location.
4. Attach hammer block on hammer arm. Slide to desired height and tighten. Attach hammer sphere to hammer block. Tighten and ensure impact will not hit accelerometer directly. Strike location should be slightly off axis from accelerometer position to protect that equipment.
5. Set up DAQ and Labview (see below).
6. One person should be running Labview and another should be dropping the hammer. The hammer should be dropped from a desired height simultaneously as the Labview program is running.
7. Process collected data to create SRS curves (raw collected data → excel → Matlab).

It is important to note that all attachment points should be tightened after each test run, especially after the hammer drops from the top height. Loose screws can heavily affect the data in terms of

both repeatability and desired results. The current strike plate can be used to test various different locations. The strike location is almost limitless because of its ability to be adjusted both vertically and horizontally. The accelerometer is limited to nine different locations drilled to follow the grid system of the plate already.

10.2 PROJECT SPECIFICATION

Table 1 shows crucial components and their respective dimensions. Data sheets for the data acquisition equipment are in the Appendix.

Table 4- Dimensions and Specifications of Components

Component	Dimensions/Specifications
Frame	34"x 34"x 26", T-slotted Al6061
Strike plate	31.63"x 31.63"x 0.19", Al6061
Hammer Block	3"x 4"x 3", Stainless steel
Hammer spheres, various sizes	1-7/8", 1-3/8", 1", 3/4", Stainless steel
DAQ	NI USB-6211, 16-bit
Accelerometer	Dytran Model 3086A4T
Signal Conditioner	PCB Piezotronics Model 482A21
Current Source Power Unity	Dytran Model 4110C

10.3 PRODUCT ASSEMBLY

Figure 1 shows the CAD assembly of the test device. Figure 2 displays a partially exploded view. It can be seen that that the hammer sphere attaches to the hammer block which attaches to the hammer arm. With a pivot attached to the top inner frame bar, the hammer arm connects to the frame. The strike plate is attached to the frame using four L-brackets at the corners of the plate. For viewing purposes, only some of the frame is exploded, but all bars of the frame are separate bars that attach in the same way.

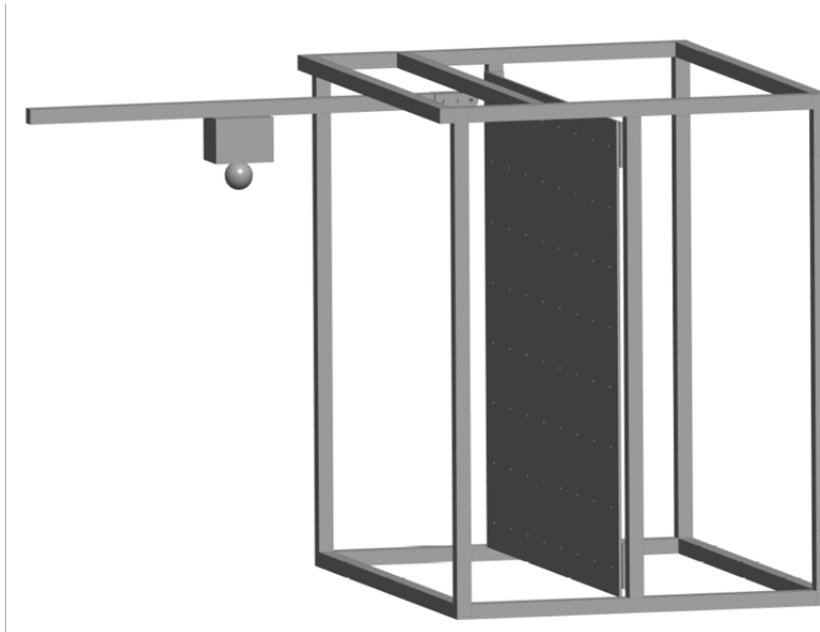

Fig. 24- CAD assembly of test device

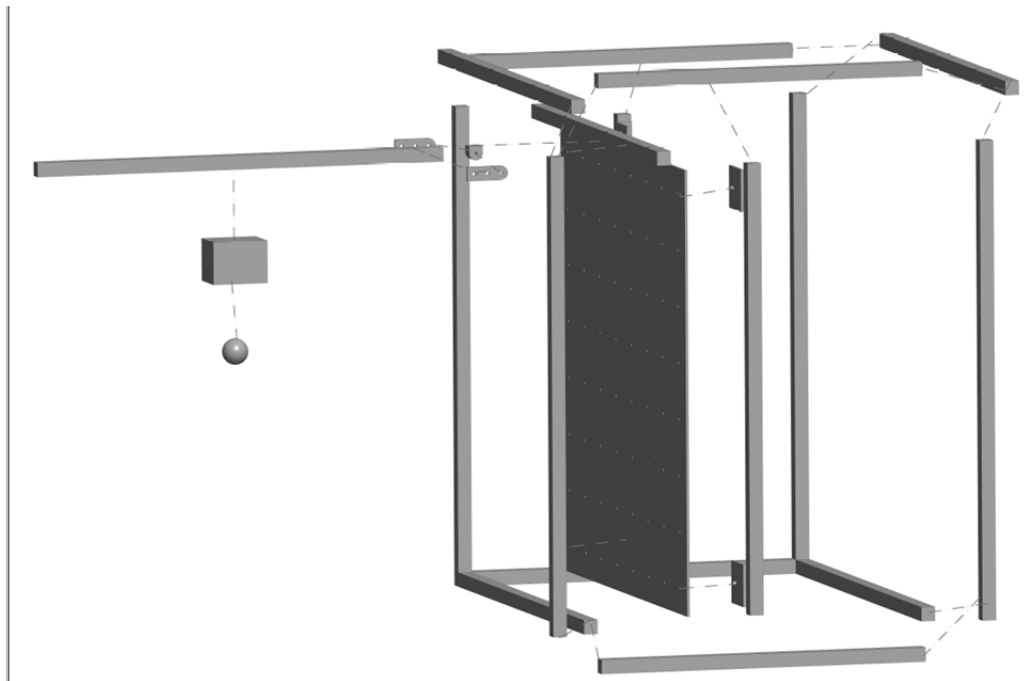

Fig. 25- Partial Exploded View of Test Device

10.4 OPERATION INSTRUCTIONS

The operating procedure for the running the physical test device was listed earlier. It is necessary to further explain the data acquisition system for users to be successful in running tests.

Data Acquisition Operation

The data acquisition system consists of various items in order to collect and record proper data. A list of this equipment is written below. Figure 3 explains the correctly ordered setup of this equipment, which is essential to proper data collection.

1. Accelerometer and attached cable with BNC connector
2. ICP signal conditioner/line filter and power cable
3. Current limiting power supply
4. Two BNC cables (1 needs stripped wires showing positive and negative ends to connect to DAQ)
5. USB DAQ
6. National Instruments LabView software installed on a computer

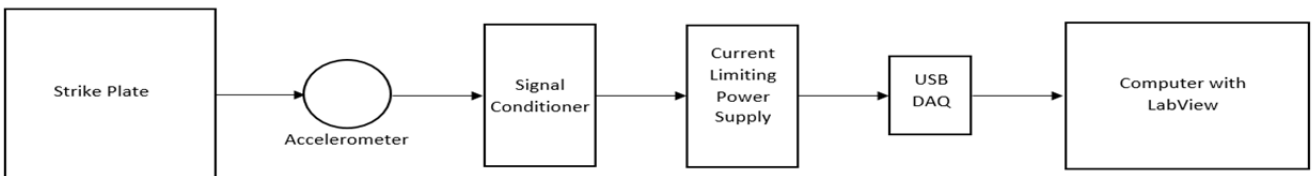

Fig. 26 - Flowchart of DAQ Hardware setup order

The next step is to build the LabView program, to read the signal output by the accelerometer. In this case, the output being read is in the form of voltage. This works well with LabView due to the easy to use DAQ Assistant. This feature allows a new user to quickly and easily setup a voltage based data acquisition system.

1. From the block diagram window, open the functions palette (right click white background)
2. Go to Express → Input → DAQ Assistant and drag the DAQ Assistant icon onto the block diagram and wait for it to automatically launch a wizard-style walkthrough (Figure 4).
3. Open the Acquire Signals drop down list.
4. Open the Analog Input drop down list and select Voltage (Figure 5).
 - a. This screen shows the supported DAQ cards installed and their associated channels. Check the DAQ Connector box and select the appropriate Card and Channel and press Next. (Figure 6) .

5. The next window is the Configuration window (Figure 7).
Here is where you set the Signal input Range, Scaling, Timing Settings, and Terminal Configuration.
6. For this project, these settings have the following Values.
Max: 10, Min: -10, Scaled Units: Volts, Terminal Configuration: "Let NI-DAQ Choose", Custom Scaling: No Scale, Acquisition Mode: N Samples, Samples to Read: 50000, Rate (Hz): 50000.

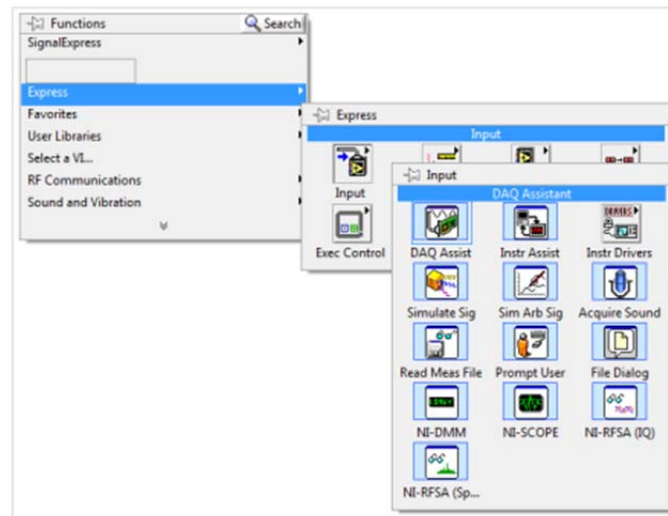

Fig. 27 - Adding a DAQ Assistant

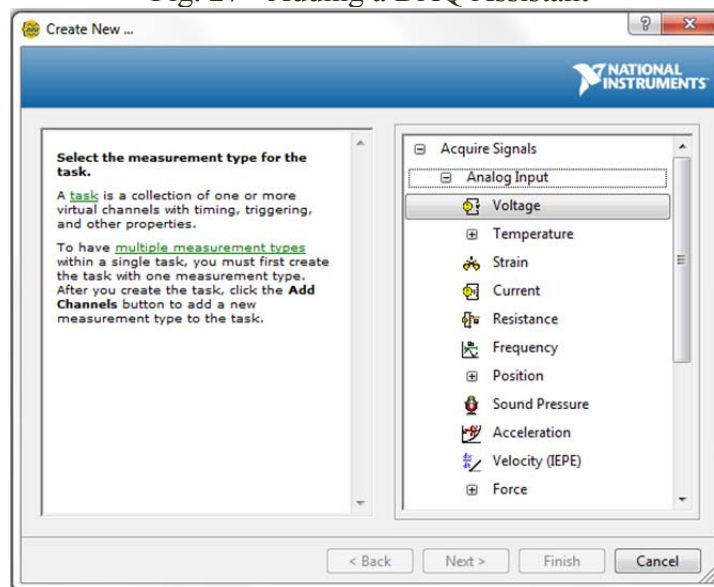

Fig. 28 - Selecting the Signal

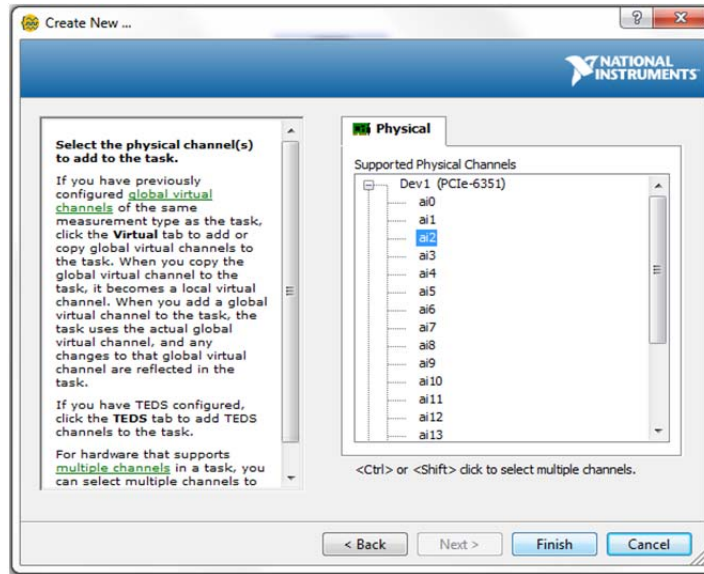

Fig. 29 - Selecting an input channel

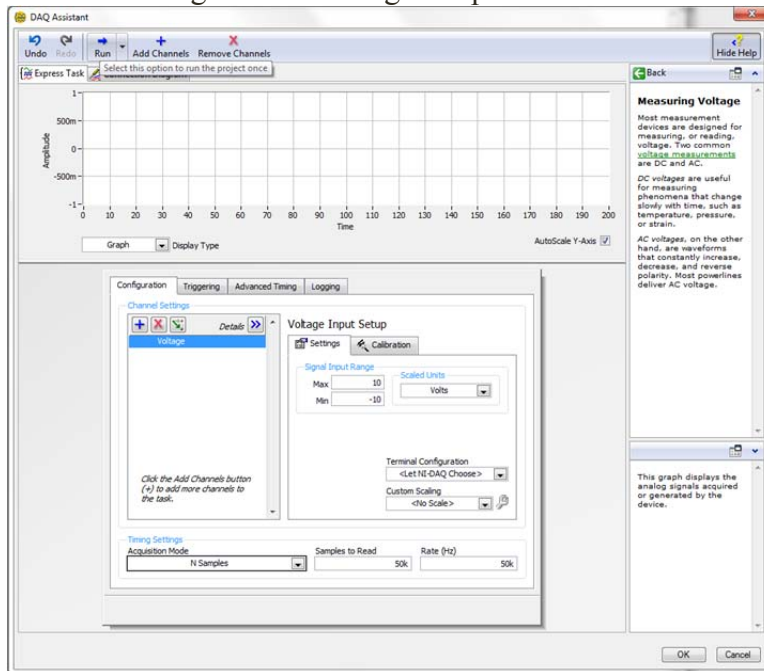

Fig. 30- Channel specific configuration page

Further development was done within LabView in order to output the data to both an on-screen graph, as well as a text file for further processing. Figure 8 shows the full block diagram and Figure 9 displays the interface screen of the program.

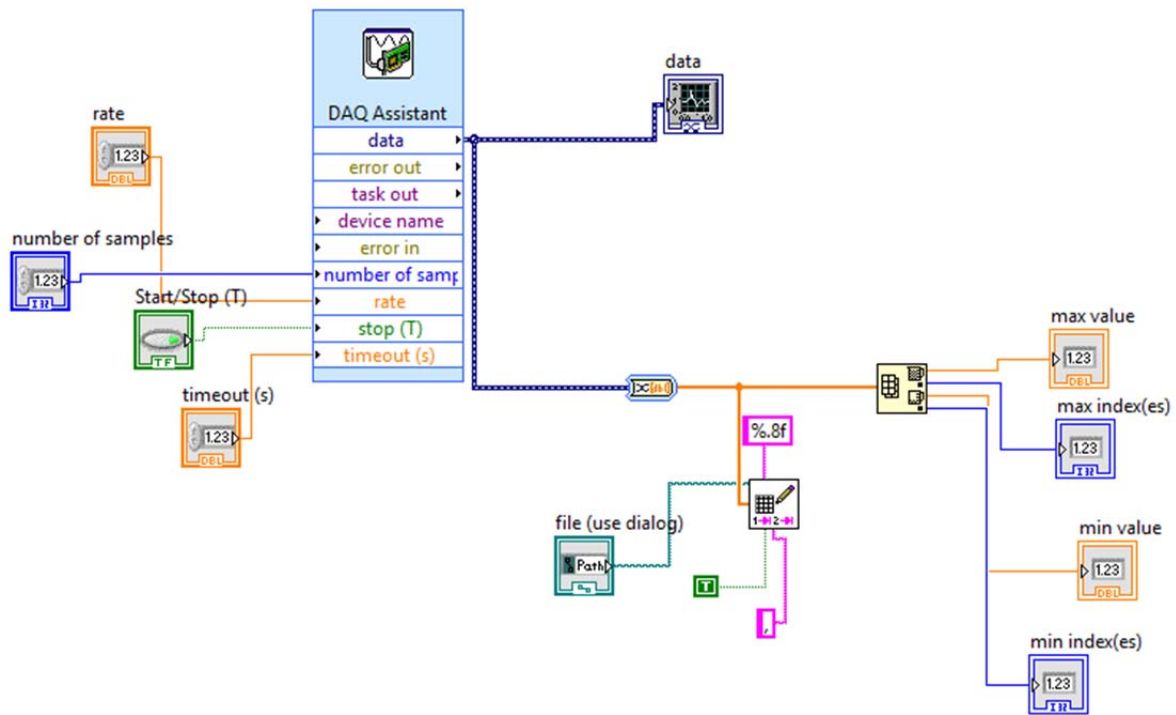

Fig. 31 - Block diagram of LabView Program

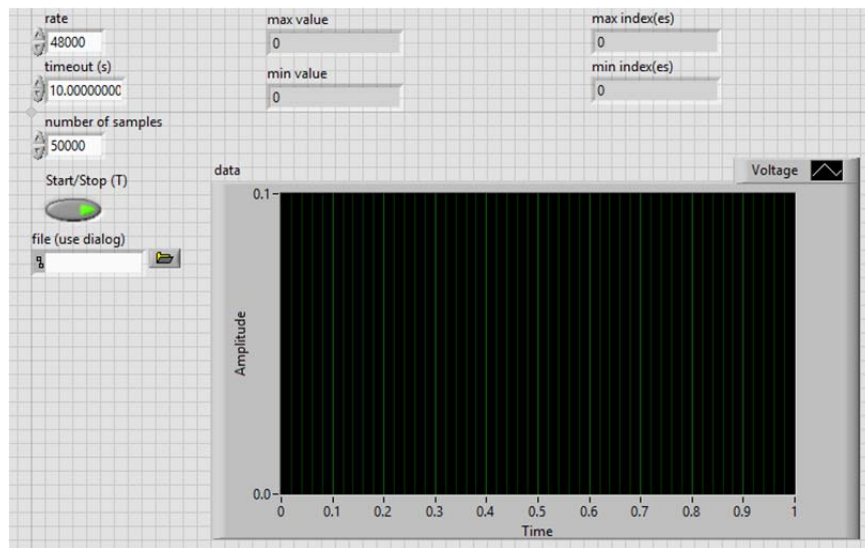

Fig. 32 - LabView user interface

The LabView blocks are created by right-clicking the various tools in the in the Data Acquisition Assistant and making control blocks. Figure 10 shows an example of creating a control block from the Data Acquisition Assistant. Outputting to a file was done by first outputting the data to

an array, then transposing this array into columns, and passing this array to a text file that will be given a name through the dialogue box on the interface. Or the data can be obtained by right-clicking the data in the user interface and exporting directly to Microsoft Excel.

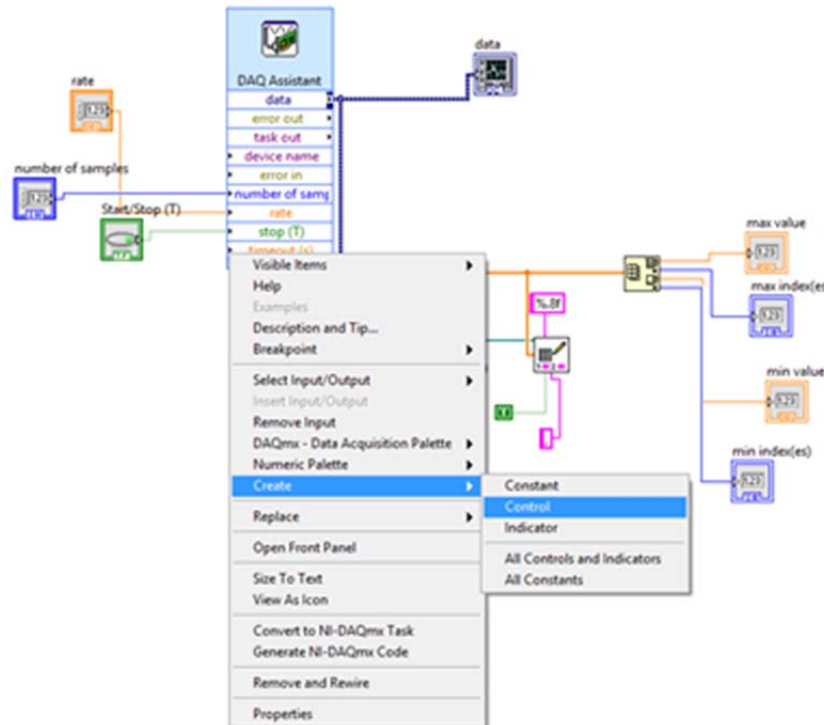

Fig. 33 - Creating a control block in LabView

After exporting the raw data (time and voltage) to Excel, a conversion factor must be used before importing that data into MATLAB. All voltages should be multiplied by _____. From there, the MATLAB codes, provided by last year's team and written by Tom Irvine, can be used to generate SRS curves. Figure ____ shows the running code with the proper answers to the given prompts. It is important that $Q=10$, but the prompts about plot formatting is based on what the user desires.

10.5 TROUBLESHOOTING

With so many variables affecting the data and various pieces of equipment needed to collect said data, issues are bound to arise. Table 2 lists some problems that may occur and possible solutions to rectify them.

Table 5- Problems and Possible Solutions for Shock Simulation

Problem	Possible Solutions
Noisy Data	Ensure DAQ is properly grounded and all connections are secure.
	Ensure the accelerometer is tightened down.
	Check that all screws and nuts are tightened.
Hammer Impact Not Consistent	Make sure pivot is not too tight.
DAQ Not Being Recognized by the Computer	Make sure proper drivers are installed
	Make sure the professional version of LabView is being used.

10.6 REGULAR MAINTENANCE

Regular maintenance of the test device should include tightening of all attachments after each test run. This is to ensure not only repeatable data, but also safety. Also, it is important to check the data acquisition equipment to make sure all is running correctly. Other than that and general inspection of the strike plate for fractures or crack, the test apparatus does not require too much maintenance.

10.7 SPARE PARTS

Figure _____ shows the table of spare parts from the team last year and an image of said parts. All of those things are still part of the inventory, and most of them will not be used. Specific to this year, the test article mounting plate has now become a spare part as well

since it is no longer being used and the accelerometer is being mounted directly to the strike plate.

Table 1 - Spare Parts Inventory

Description	QTY	Notes
Long Stiffening Bands	3	8 holes, 4" spacing
Short Stiffening Bands	4	4 holes, 4" spacing
Sacrificial Plates	4	Specific to Hammer Tip Size
Bushings	6	70 Durometer
T-Slot Brackets	12	
Short Hex Bolts	25	Size: 1/4-20 x 7/8"
Long Hex Bolts	13	Size: 1/4-20 x 1-1/2"
Lock Nuts	13	Size: 1/4-20
Washers	90	Size: 1/4"
Nuts	90	Size: 1/4-20
T-Slot Hardware	5 Bags	Nuts and Bolts
Lanyard	1	Length: 15ft
Long Threaded Rod	1	Size: 3/8-16 x 8"
Short Threaded Rod	1	Size: 1/4-20 x 1-1/2"
T-Slotted Aluminum	1	Size: 1" x 6' Solid
Angled Steel	1	Size: 3" x 3" x 1'



Figure 6 - Spare Parts

Fig. 34 - Table and Image of Spare Parts from Team 15 Last Year

11 PROJECT MANAGEMENT

Communication

The main source of communication for the group was WhatsApp which is a group messaging application for mobile devices that allowed the group to stay in contact at all times. It is a free app that allowed the team to schedule meetings and discuss aspects of the project and share ideas outside of physical meetings. In addition the team used email, Google Drive, and

USB drives to share information. Once in contact with Harris, weekly teleconferences were scheduled to discuss the progress of the group and future steps to advance the project.

Timeline

At the beginning of the year the team needed to gain an understanding of what was expected of this project. Since this project was a continuation from last year, the objectives for this year needed to be clearly understood. By the end of October the goals for this year's project were clearly stated and work began on trying to achieve repeatability from the test apparatus. November and December were spent looking into methods to achieve repeatability and making the various modifications to the device. This work continued into the second semester with more finely detailed modifications being researched such as extra dampers and after purchasing a DAQ more tests could be run. February was spent collecting data to finalize the repeatability of the test device and variable testing began in March. By the beginning of April the variable testing that was put forth by Harris and our advisor Dr. Kumar was completed and the team can start drawing conclusions from these tests.

Resource Assignment

The resources that were utilized during last years project again proved to be invaluable. Dr. Kumar was able to clearly stated the goals for the project this year and helped achieve a DAQ for use until one was purchased and helped to pinpoint the aspects of the project that needed to be addressed first. The team sponsor Harris Corp. again brought in specialists Gianni Cornejo and Sarah Cooper to help aid the team during teleconferences. Mr. Cornejo was particularly helpful in analyzing the data that was being collected and pointing out aspects that

needed to be troubleshooted and offering insight as to what was happening during the test runs. Mrs. Cooper aided the team by also providing insight by sending an article with detailed information about the frequencies of SRS curves and how it pertains to particular geometries. All of the help from Harris Corp. helped better the team's understanding of SRS curves and when variable testing started, what was happening as the strike location and the sensor location were changed. Also Dr. Clark allowed the use of the operations table in the advanced mechatronics laboratory which was crucial to the repeatability of the device. Without a secure form of anchoring the device has very little chance of being repeatable.

Critical Tasks

Gaining access to the previous year's work was the first most important task that needed to be done. Once all last year's work was procured, then the team could begin working on what needed to be improved and making the necessary adjustments to the device. Since the adjustments being made did not need the use of the machine shop these changes happened fairly quickly which allowed for testing to begin quickly as well. One of the changes that needed to be made was the anchoring of the device and this needed to be greatly improved from last year. Finding a way to anchor the device more securely than simply weighing it down proved to be not as time consuming as previously thought as Dr. Kumar directed us to operations table under the supervision of Dr. Clark in the advanced mechatronics lab. Purchasing a DAQ for the team was also very important as the DAQ that was being used previously was being borrowed by Dr. Kumar and needed to be returned by February. The purchasing and shipping of the DAQ needed to be done in a timely manner otherwise no testing could be done and this would have put the team back significantly.

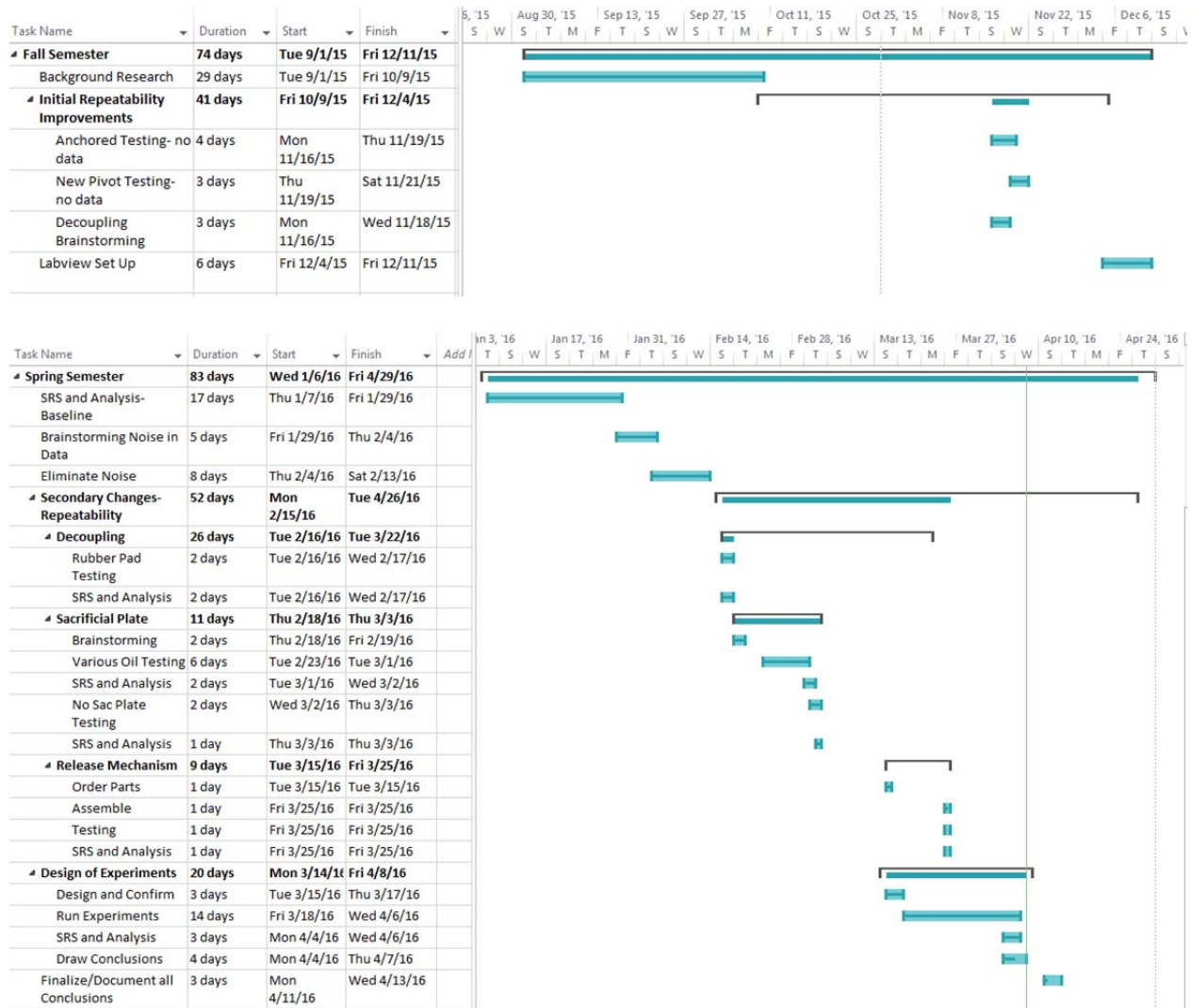

Fig. 35 - Table and Image of Spare Parts from Team 15 Last Year

12 CONCLUSION

This project aimed to build a better understanding of the complex and chaotic nature of hammer blow testing and pyrotechnic shock simulation. Despite some setbacks in the first semester of the project, the team learned a great deal about the effects certain parameters had on resultant SRS curves. Developing a system that reliably outputs repeatable data was the first objective of this project because without repeatable data, any testing or experiments would be meaningless.

Unfortunately, the testing apparatus built by last year's team contained a slew of noisy variables that needed to be eliminated, or at the very least, ameliorated. These sources of noise – such as the wobbly static joint that was being used as the swing arm pivot – were eventually resolved so that multiple tests would result in overlapping SRS curves, a clear indication of repeatability.

There was initially confusion amongst the team members surrounding the aim of this pyrotechnic shock simulation project. Initially, the team was under the impression that a new prototype had to be constructed to replace last year's rig. After several teleconferences with Harris via Skype, and a meeting with our advisor Dr. Kumar, it became apparent to us that our first step was to improve upon the already-constructed hammer blow testing apparatus. Unfortunately, this resulted in an initial delay in the fall semester. It is worth noting that this could have been prevented had the team met with Dr. Kumar much earlier; the first meeting with him did not take place until October.

The experiments showed that the test rig was indeed capable of producing repeatable data at various strike and read locations. Testing at various locations on the strike plate also allowed us to visualize the harmonics associated with its vibratory behavior. Further testing should include an investigation into how certain variables (such as hammer mass and plate material) affect these harmonics, as well as peak accelerations in the high frequency range.

In retrospect, hammer blow testing is an excellent way of simulating pyrotechnic shock without the dangers and uncertainties involved with actual explosives. Our team hopes that the resulting SRS curves and information that we have generated will allow Harris to further their understanding of the idiosyncrasies involved with this testing method.

REFERENCES

1. DeMartino, Charles, Chad Harrell, Chase Mitchell, and Nathan Crisler. *Impact Testing and Pyrotechnic Shock Modeling Final Report*. Senior Design Team 15. Web. 10 April. 2015.
<http://eng.fsu.edu/me/senior_design/2015/team15/Final_Report_Team15.pdf>.
2. Wells, Robert. "University Capstone: Development of Hammer Blow Test Device to Simulate Pyrotechnic Shock (Second Year Project)." 14 Aug. 2015.